



# IDEAL 7000TLX

**‘Low Rise / Portable / Storable’**

## **Automotive Tilt Lift**

**7,000 lb. Capacity**



## **Assembly & Operation Manual**

### **IMPORTANT NOTICE !!**

**FOR USE WITH UNIBODY CONSTRUCTED VEHICLES ONLY  
(FRAME CHASSIS MAX WIDTH OF 61" & MIN WIDTH OF 48")**

# TABLE OF CONTENTS

## **SAFETY INFORMATION**

- Note, Caution and Warning
- Important Information
- Safety Instructions

## **TECHNICAL INFORMATION**

- Product Description
- Specifications

## **BEFORE USING**

- Site Selection
- Surface Condition
- Operating Conditions

## **INSTALLATION INSTRUCTIONS**

- Required Tools
- Shipping Crate
- Package Contents
- Tilt Lift Assembly
- Tilt Lift Preparation (Lowering)

## **FINAL PREPARATION & POSITIONING**

- Jack Stand Preparation
- Positioning Tilt Lift Under Vehicle
- Basic Vehicle Layout Positions

## **OPERATION INSTRUCTIONS**

- To Raise Vehicle
- To Lower Vehicle
- To Tilt Vehicle
- Tilt Lift Storage
- Manual Handle & Adapter

## **INSPECTION, MAINTENANCE & CLEANING**

- Before Each Use
- Daily
- Monthly

## **EXPLODED VIEWS & PARTS LIST**

## **LIMITED WARRANTY**

# SAFETY INFORMATION

## Note, Caution and Warning

This document uses the following notations: Note, Caution and Warning . to alert you to special instructions, tips, or hazards for a given procedure. Please familiarize yourself with the notation explanations described below.

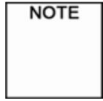

Indicates important information that requires special attention, such as a procedure for a specific vehicle, or tips on operating the equipment.



Indicates the potential for damage to equipment, accessories, or the vehicle unless the instructions or procedure are followed specifically.



Indicates the potential for property damage, personal injury, or death due to hazards associated with the equipment, vehicle, or environment. Do not perform any procedures until you have read and understood the warning instructions.

## Important Information

1. **Read this manual thoroughly** before installing, operating, or maintaining the lift.
2. **This lift is rated to 7,000-lbs lifting capacity.** NEVER EXCEED rated lifting capacity of lift.
3. **This lift is designed for indoor & outdoor use** and should not be installed in a pit or depression.
4. **The floor/surface on which the lift is to be used should be smooth and flat** as possible.
5. **The lift has specific mechanical requirements** as described in the Installation Instructions section of this manual.
6. **This lift has a minimum vehicle height requirement** as described in the Installation Instructions section of this manual.
7. **Failure by the owner / operator to provide the power drill requirements, proper surface, and recommended shelter** (when not in use) could result in unsatisfactory lift performance, property damage, or personal injury.
8. **Do not attempt to install / assemble this lift** if you have never been trained on basic automotive lift installation procedures.
9. **Stay clear of any moving parts** that cause injury.
10. **The operation of the lift is permitted by authorized persons only.**

## Safety Instructions

1. **Only trained personnel should operate this lift.** All non-trained personnel should be kept away from work area. Never let non-trained personnel come in contact with or operate lift.
2. **Do not raise a vehicle on the lift until the installation is completed** as described in this manual.
3. **Technicians should be trained to use and care for the lift by familiarizing themselves with the manual**, including Note, Caution and Warning information. The lift should **never be operated by an untrained person**.
4. **Do not overload the lift.** The capacity of the lift is shown on cover of this manual and on the lift's serial number tag.
5. **Keep everyone clear of the lift when the lift is moving**, the locking mechanism is disengaged or if the vehicle is in danger of falling.
6. **Unauthorized personnel should never be in the shop area** when the lift is in use.
7. Inspect the lift daily. **The lift should never be operated if it has damaged components or is malfunctioning. Replace damaged components with manufacturer's parts, or equivalent.**
8. **Keep area around lift clear of obstacles and well lighted.**
9. **To reduce the risk of personal injury**, keep hair, loose clothing, fingers, and all body parts away from moving parts.
10. **To reduce the risk of electric shock**, do not operate the lift when wet, do not expose the lift to rain.
11. Use the lift only as described in this manual, **use only manufacturer's recommended attachments.**
12. **Anyone who will be in the vicinity of the lift when it is in use should familiarize themselves** with any Caution, Warning, and Safety related decals supplied with this lift, and replace them if they are illegible or missing.
13. **Always ensure that the safety support jack is in place** before any attempt is made to work on or work near the vehicle, after being lifted & tilted.
14. **Always wear safety glasses.** Everyday eyeglasses may only have impact resistant lenses, and not impact resistant frames. These are not safety glasses.
15. **Maintain with care.** Keep lift clean for proper & safe performance. Follow manual for proper lubrication and maintenance instructions.
16. **Check for damaged parts.** Check lift & stand for proper alignment of moving parts, breakage of parts or any condition that may affect the lift's operation. Do not use lift if any component is broken or damaged.
17. **Never remove safety related components from the lift.** Do not use lift if safety related components are damaged or missing.

# TECHNICAL INFORMATION

## Product Description

The iDEAL 7000TLX (TLX-7000) is a low-profile, lightweight, portable 7,000 lb. capacity low-rise scissor frame contact tilt lift. Equipped with twin dual-action precision gear drive mechanisms & dual independent safety lock bar devices, the lifting operation is simply powered by the torque supplied from an electric handheld drill. The exclusive twin dual-action gear drives & independent safety lock bars also allow for full operation from either side of the lift. The unique and easy-to-use vehicle lift & tilt operation provides greater overall accessibility to vehicle, while also being able to quickly & conveniently be stowed out of the way. The iDEAL 7000TLX consists of a tilt lift assembly, jack stand, platform risers, drill drive adapters, safety lock pins, wall mount storage brackets & manual handle with socket adapter. Optional Floor Rail Kit also available.

## Specifications

Specifications	TLX-7000
Lift Capacity:	7,000 lbs.
Overall Length	51-3/4+
Overall Width	64-3/8+
Min. Height	4-1/2+
Max Lift Height	22-1/2+or 23-1/2+w/ Risers
Lift Speed	*30 to 40 sec.
Lift Weight	111 lbs.
Platform Length & Width	31-1/2+x 7-1/4+
Min / Max Width - Outside Platforms	59-1/4+- 63-3/4+
Min / Max Width - Inside Platforms	44-1/2+- 49-1/4+
Power (Supplied By Customer / Operator)	10Amp - 120VAC 1/2+Corded Drill**
Ship Weight	214 lbs.

\* Depending on Power Drill Amperage & Vehicle Weight.

\*\* Cordless Drills Not Recommended & Impact or Pneumatic Drills Should Not Be Used!

## BEFORE USING

### Site Selection

- **LIFT LOCATION:** Check layout dimension against floor plan requirements making sure that adequate workspace is available. The floor surface on which the lift is to be used should be smooth and flat as possible.
- **OVERHEAD OBSTRUCTIONS:** The area where the lift will be located should be free of overhead obstructions such as heaters, building supports, electrical lines etc.

### Surface Condition

- Do not use the Lift on any type of asphalt or soft surface. Ensure lift is placed on a dry, oil & grease free, level concrete surface capable of supporting the weight of the Lift with a vehicle. Do not use Lift on concrete expansion seams or cracked, defective concrete. Failure to accomplish the foundation surface requirements may cause lift instability, which could result in personal injury.

### Operating Conditions

- Operate lift only between temperatures of 41° - 104° F

# INSTALLATION INSTRUCTIONS

NOTE

These instructions must be followed to ensure proper installation and operation of your lift. Failure to comply with these instructions can result in serious bodily harm and void product warranty. Manufacturer will assume no liability for loss or damage of any kind, expressed or implied resulting from improper installation or use of this product.

## Required Tools

- Scissors
- Hammer or Small Crowbar
- 30mm Open-End Wrench
- 30mm Socket Wrench
- 10 Amp\* 120VAC 1/2"+Corded Drill - **DO NOT Use Impact Drill !!**  
(\*Less than 10 Amps may cause difficulty raising larger & heavier vehicles)



**Shipping Crate weight is approximately 215 lbs. Careful attention should be taken for offloading & maneuvering Crate. The 66.3”L x 34.8”W x 10.4”H Crate is designed for easy mobility with forklift or pallet jack.**

## Shipping Crate

1. Inspect shipping crate for any damages.
2. Open shipping crate by first cutting banding, followed by carefully prying lid open.
3. Carefully remove all contents from crate, using Package Contents list & diagram below to ensure all items are included.



## Package Contents

- A.** Tilt Lift Frame Assembly (1)
- B.** Platform (2)
- C.** Platform Hardware:
  - Pivot Bar (2)
  - Spacer (4)
  - Flat Washer (4)
  - Nylon Nut (4)
- D.** Platform Riser Bar (2)
- E.** Drill Drive Adapter (4)
- F.** Safety Lock Pin (2)
- G.** Handle & Socket Adapter (1)
- H.** Wall Storage Bracket (2)
- I.** Jack Stand

### For Convenience

The iDEAL 7000TLX Tilt Lift comes almost fully assembled. Only the Platform Assemblies need to be mounted to the Tilt Lift Frame. (See Assembly Info Next)

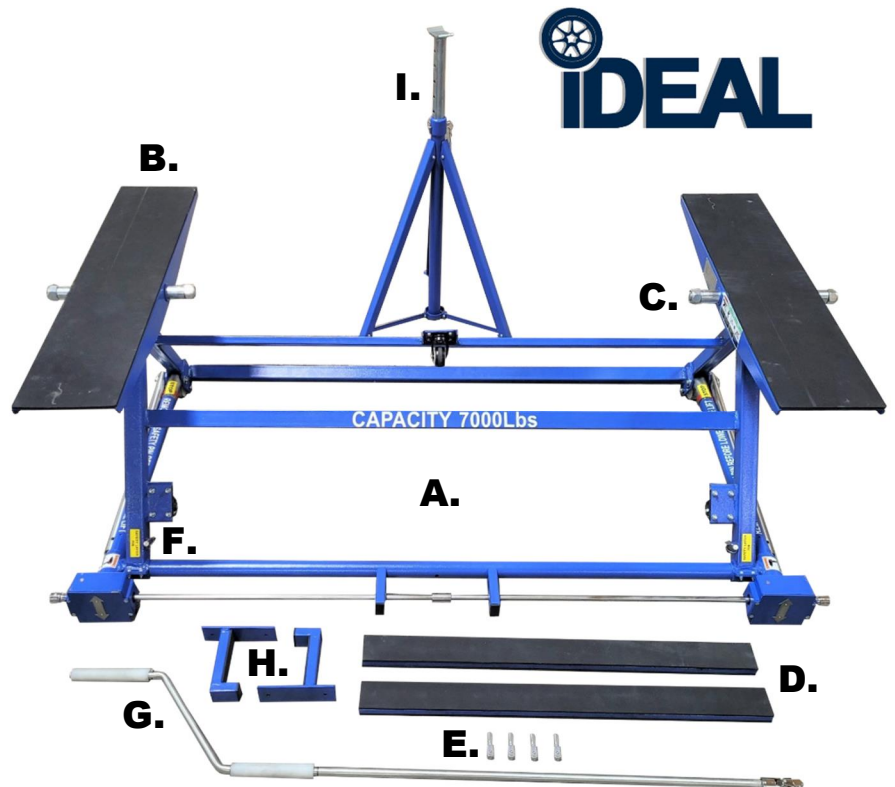



## Tilt Lift Assembly

1. Raise Frame Arms up so both pivot holes align to each other. Locate Pivot Bars, Flat Washers, Spacers & Nylon Nuts to mount Platforms. (Slightly coat interior of pivot holes with lithium grease.)



2. Insert Pivot Bar into Frame Arm holes. Apply Flat Washers to each side, as shown below.

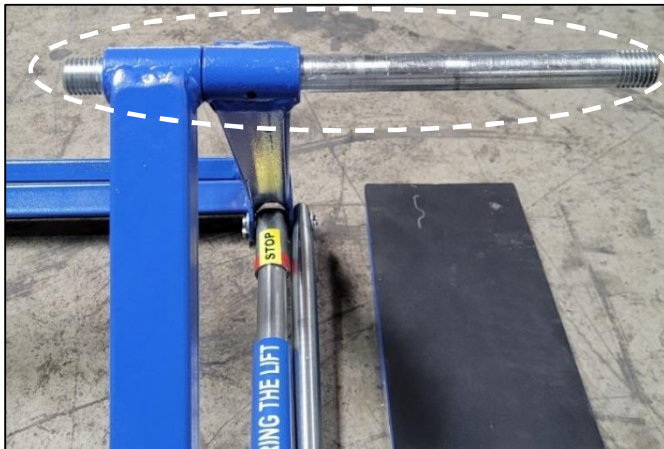

3. Bias Pivot Bar to outside & slightly tilt Platform down to insert Bar thru the outer hole (A); then level to inner Platform hole (B) to fully insert Pivot Bar. Insert Spacers to each side, as shown below.

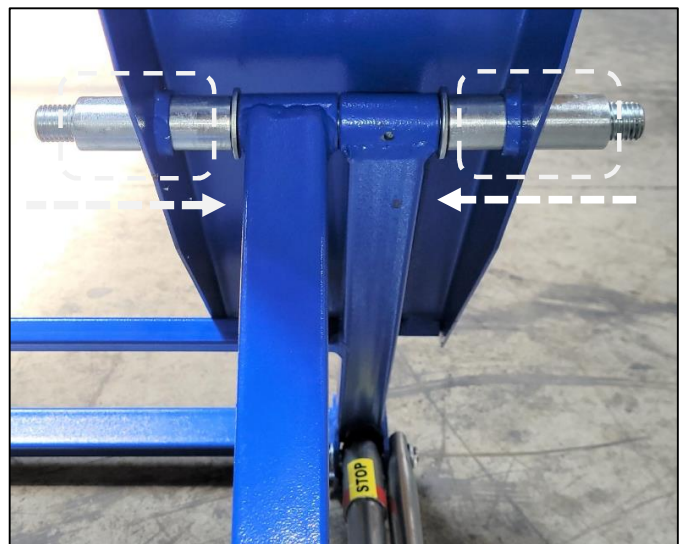
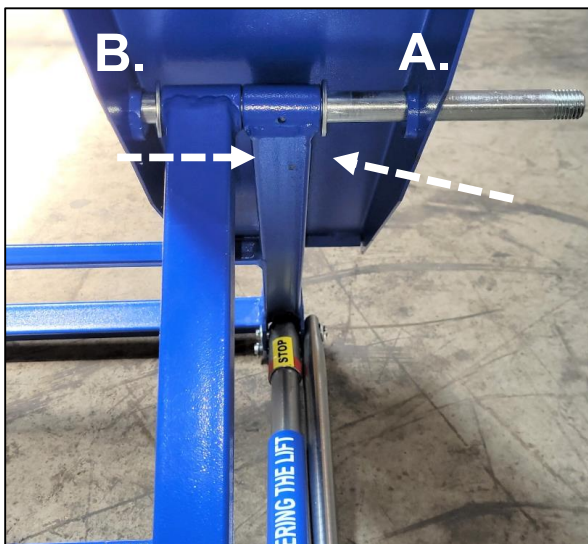



4. Ensure Platform, Pivot Pin, Washers & Spacers are properly installed to Tilt Lift Frame, as shown below. Once confirmed, apply Nylon Nuts to each end of Pivot Pin to secure Platform assembly to Lift Frame, using 30mm wrench & socket. Duplicate assembly steps 1-4 for opposite Platform.

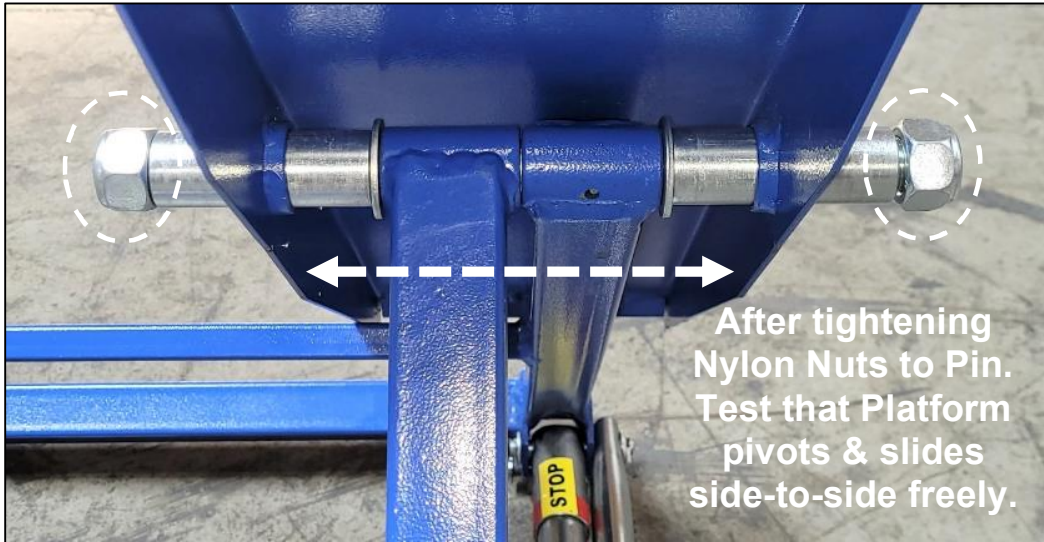

### Tilt Lift Preparation (Lowering)

1. Insert Drive Adapter into Power Drill and insert into either Gear Box. Note Direction to lower DOWN.



***(Note: Drill's 'Forward or Reverse' to Lower Lift from either side. Manual Handle can also be used to Lower.)***

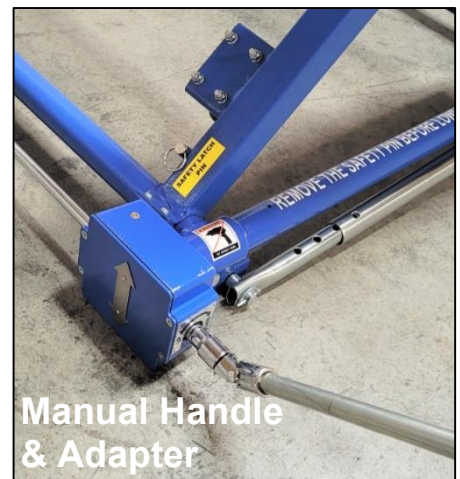
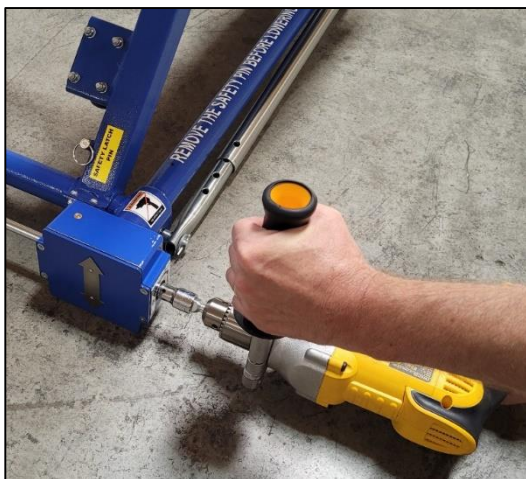



2. Based on which Gear Box is being used, gently apply power to drill to confirm the correct rotation of drill to lower lift DOWN. Once confirmed, slowly begin applying power to drill to fully lower Lift.



3. Once Lift has been lowered, it's now configured to roll on Casters to easily position under vehicle.



**NOTE**

You may see some grease on sides of drive shafts as lift raises & lowers. This is normal and the amount of grease will reduce with use.

**This Completes the iDEAL 7000TLX Tilt Lift Assembly.**

# FINAL PREPARATION & POSITIONING

## Jack Stand Preparation

1. Position Jack Stand in vertical position.
2. Fully unfold legs of Jack Stand for proper stability.
3. Remove Pin to adjust to Pillar & Pad to desired height.



## Positioning Tilt Lift Under Vehicle

1. Ensure vehicle is positioned on a dry, oil & grease free, level concrete surface capable of supporting the weight of the Lift with a vehicle
2. Before using Tilt Lift, always put vehicle in Park and set Emergency Brake.
3. Position the Tilt Lift under vehicle closest to front wheels by rolling the Lift under vehicle.
4. Adjust Platforms to chassis frame rails. If pinch welds or body molding interferes with Platform surface, place Riser Bars on Platforms before raising vehicle.
5. Double check for proper clearances between Platforms and chassis frame rails prior to lifting vehicle.

## Basic Vehicle Layout Positions

- A. Front Engine / Front Wheel Drive** - recommended to position iDEAL Tilt Lift under vehicle so that the gear boxes are positioned about 4+ behind the front wheels.
- B. Front Engine / Rear Wheel Drive** - recommended to position the iDEAL Tilt Lift under vehicle so that the gear boxes are positioned about 12+ behind the front wheels.
- C. Rear Engine / Rear Wheel Drive** - recommended to position the iDEAL Tilt Lift under vehicle with gear boxes facing towards rear wheels so that the gear boxes are positioned about 4+ from the back wheels.

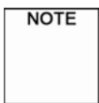

Recommendations noted above should be used as a 'base-line' for the iDEAL Tilt Lift placement. You may need to adjust the lift's position 'front or back' an inch or two in order to obtain easy vehicle tilting. Once the best balance placement for the lift & vehicle has been established, it is recommended to mark the underside of vehicle for future usage.



For Use Only with Unibody Constructed Vehicles with Maximum Chassis Width of 61" & Minimum Chassis Width of 48". Failure may result in Vehicle and/or Lift Damage.

# OPERATION INSTRUCTIONS

## To Raise Vehicle:

- Place vehicle in PARK and set Parking Brake.
- Use on hard level surfaces only, keeping area clear around vehicle.
- Measure the width between chassis frame rails for correct Platform location.
- Roll lift under vehicle with the Drive Gearbox, typically closest to front wheels.
- Position lift Platforms under both the driver's & passenger's side of the vehicle's frame. If necessary, adjust Platforms side-to-side for proper alignment to chassis frame.



**Vehicles with pinch welds may require Platform Riser Bars for proper clearances to avoid causing damage to vehicle or lift.**

- Insert Drill Adapter into drill and tighten.
- Select which side of Tilt Lift & vehicle will be best to work from. (See NOTE Info. below)

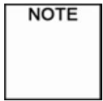

**The IDEAL 7000TLX is equipped with twin dual-action gear drives & dual independent safety lock bars & safety pins. The twin dual-action gear drives & dual independent safety lock bars allow for full operation from either side, using the 'forward & reverse' function of the power drill.**

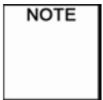

**For single direction drills, lift operation can still be easily utilized by using the side-specific gearbox for 'Up & Down' lift operations, as indicated on the Gearbox decal plates.**

- Connect power to Drill, double checking drill's rotation, prior to inserting Adapter into Gearbox Socket.



**Before raising vehicle, verify that there is enough overhead clearance for vehicle once raised & tilted.**

- Raise lift until lift Platforms contact the chassis frame of the vehicle. If Platforms are not lining up properly, lower lift slightly and readjust Platforms.
- Once lift is reset and Platforms are properly adjusted, raise lift to desired height. Lifting slowly.



**As you raise the vehicle, typically the front half of the vehicle will begin to drop as the rear of vehicle raises.**

- Once lift is at desired height and one set of wheels are touching the ground, insert Safety Locking Pin into one of the Safety Lock Bars.



**Always Insert Safety Lock Pin, after vehicle has been raised to the desired height.**

- Position Jack Stand under raised side of the vehicle. Adjust the Pillar height to support a solid section of vehicle chassis, followed by inserting pin into hole to lock Pillar into position. Ensure Jack Stand is placed on solid surface able to support vehicle.

## To Lower Vehicle:

- Ensure area around & under the lifted / tilted vehicle is clear of any obstructions that may interfere with vehicle coming down.
- Carefully, remove Jack Stand from under vehicle. Ensure to locate Stand clear of vehicle & lift.
- Remove Safety Locking Pin. Insert into storage position on lift.
- Insert Drill Adapter into the Gearbox Socket, using the forward & reverse function of power drill to lower lift. Double check rotation of drill to lower lift, as noted on UP & DOWN arrows for each Gearbox.
- Slowly lower vehicle until all four wheels are touching the ground and the lift Platforms are clear of the vehicle frame.
- Once lift is completely lowered, roll lift out from under vehicle and store for later use.



**Never Drive Over Tilt Lift!! Damage to Vehicle and Tilt Lift Will Occur!**

## To Tilt Vehicle:

- Vehicles come in different sizes, configurations, engine locations & weights. **Refer to the Basic Vehicle Layout Positions, noted on page 10.**

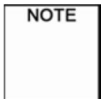

**You may need to adjust the lift's position 'front or back' an inch or two in order to obtain easy vehicle tilting. Once the best balance placement for the lift & vehicle has been established, it is recommended to mark the underside of vehicle for future usage.**

- In order to tilt the vehicle, carefully lift vehicle from the lowered end that has wheels touching the ground.



**Never Pull Down from the Vehicle End that is Raised. Damages to Vehicle may Occur.**

- Ensure to lift to tilt vehicle from a solid part of the of the vehicle, like the fender, bumper, frame, etc.



**Never Lift & Tilt Vehicle from Fragile Decorative type Parts of Vehicle.**

- Once the vehicle starts to rise & tilt, control rise by using two hands to control vehicle transitioning onto the opposite wheels. Try not to let the vehicle bounce, as damages may occur.
- Always position Jack Stand under the tilted vehicle to ensure vehicle will not unexpectedly tilt back or down while working on vehicle.



**When raising, lowering and especially tilting vehicle, ensure there is enough room under the bumpers, so damages will not occur.**



## Tilt Lift Storage

- The iDEAL 7000TLX comes standard with Wall Storage Brackets. Brackets are designed to support full weight of the Tilt Lift.
- Mounting hardware is purposely not included, allowing the customer the ability to choose the type of wall anchoring hardware that is best for their wall mounting application. Wall Bracket holes allow for 1/4+ mounting hardware.
- Wall Bracket spacing should be positioned to the inside section of tubular lift frame, as shown below. The Tilt Lift can also be carefully leaned against wall.
- Carefully raise Tilt Lift to an upright position, with Gear Boxes on top. Lift & position Tilt Lift onto Wall Brackets so that the lift is supported by the tubular lift frame between the gear boxes, circled below.



## Manual Handle & Adapter

- The Manual Handle & Socket Adapter can conveniently be used in place of the Power Drill or in cases of power outages and/or when power may not be available.

## INSPECTION, MAINTENANCE & CLEANING



**Always unplug the Power Cord from the electrical outlet before performing any inspection, adjustments, maintenance and/or cleaning.**

**BEFORE EACH USE:** Inspect the general condition of the Drill, Lift & Jack Stand. Check for loose screws, misalignment or binding of moving parts, broken parts, damaged electrical wiring, and any other condition that may affect its safe operation. If abnormal noise or vibration occurs, have the problem identified and corrected before further use. **Do Not Use Damaged Equipment.**

**DAILY:** With compressed air or vacuum, remove all dirt and debris from the Lift. Also, use a mild detergent or cleaner to remove oil and grease from the unit.

**MONTHLY:** While the factory has pre-greased the Gear Drive Boxes & Drive Screw Bars, we recommend that you periodically check and add white lithium grease as required. Grease is designed to reduce friction of the gears and screw drives internally.

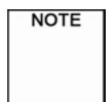

**The iDEAL 7000TLX conveniently has Grease Zerks applied to the top each Gearbox for the ease to add grease, when required.**



**Depending on how often you use the Lift, you should check Gear Drive Box periodically to ensure there is enough lubrication to keep friction, wear & tear to a minimum.**

**For iDEAL Technical Assistance, please call 877-558-9337.**

# EXPLODED VIEWS

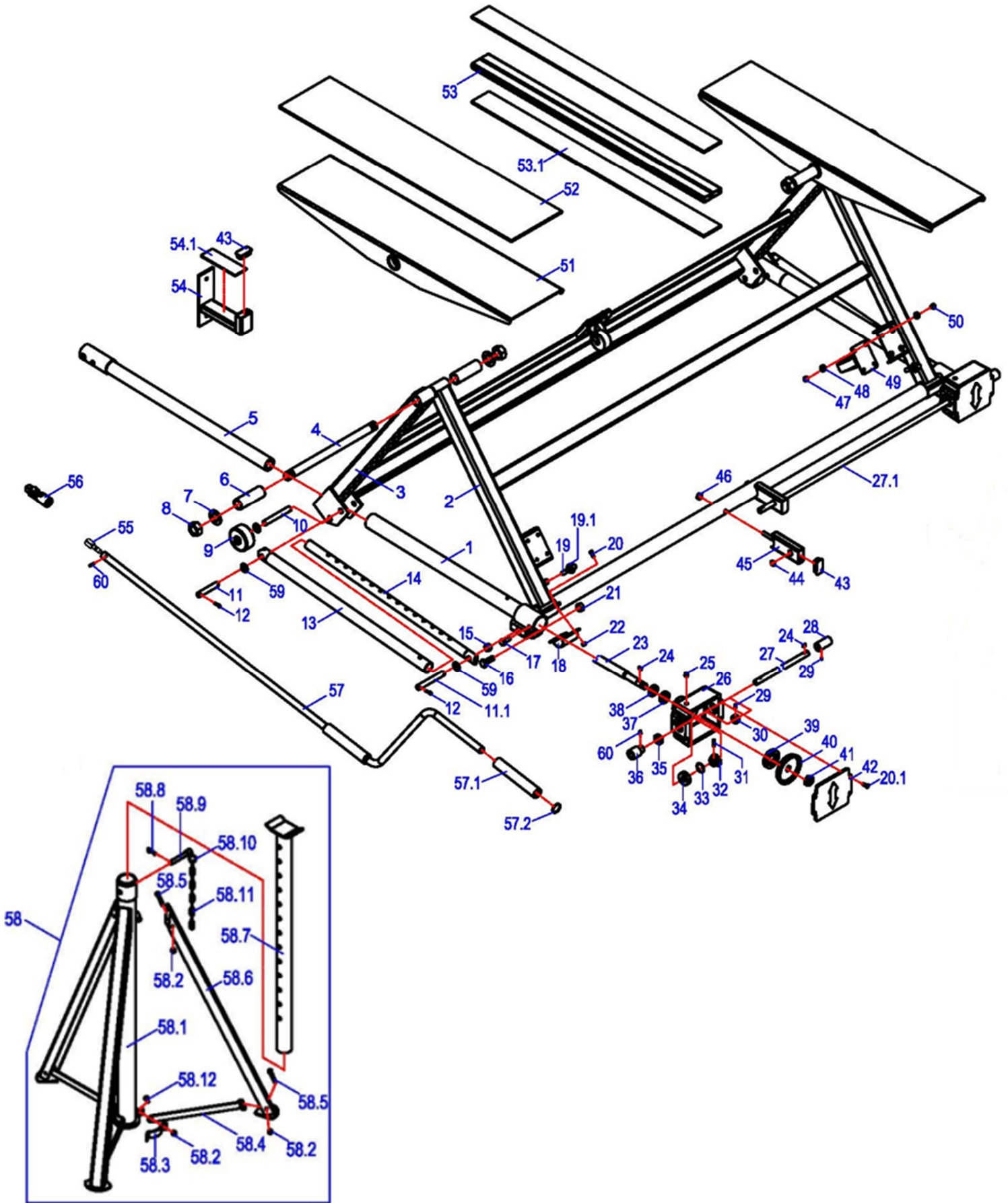

# PARTS LIST

ITEM	Tux P/N	M-REF P/N	DESCRIPTION	QTY
1	TLX-7000-001	SL03-01000-000	Outer Drive Bar Tube	1
2	TLX-7000-002	SL03-02000-000	Inner Scissor Frame	1
3	TLX-7000-003	SL03-03000-000	Outer Scissor Frame	1
4	TLX-7000-004	SL03-00013-000	Platform Pivot Bar	2
5	TLX-7000-005	SL03-05000-000	Inner Drive Bar Tube	2
6	TLX-7000-006	SL03-00014-000	Platform Spacer	4
7	TLX-7000-007	5301-00020-000	Flat Washer, D20	4
8	TLX-7000-008	5206-00020-000	Lock Nut, M20	4
9	TLX-7000-009	SL03-00009-000	Nylon Wheel	2
10	TLX-7000-010	SL03-00004-000	Wheel Pin, D12x66	2
11	TLX-7000-011	SL03-00015-000	Outer Lock Bar Pin, D12x88	2
11.1	TLX-7000-011.1	SL03-00024-000	Inner Lock Bar Pin, D12x71	2
12	TLX-7000-012	5404-03020-000	Cotter Pin, D3x20	12
13	TLX-7000-013	SL03-00003-000	Outer Lock Bar Tube	2
14	TLX-7000-014	SL03-00002-000	Inner Lock Bar Tube w/ Holes	2
15	TLX-7000-015	SL03-00016-000	Small Spacer	2
16	TLX-7000-016	5104-10035-001	Bolt, M10x35	2
17	TLX-7000-017	5104-08010-001	Bolt, M8x10	2
18	TLX-7000-018	SL03-00001-000	Half-Moon Collar Clamp	2
19	TLX-7000-019	SL03-00022-000	Safety Latch Pin	2
19.1	TLX-7000-019.1	SL03-25003-FJ6	Ring	2
20	TLX-7000-020	5110-05014-000	Screw, M5x14	8
20.1	TLX-7000-020.1	5107-05010-000	Screw, M5x10	8
21	TLX-7000-021	5206-00010-000	Lock Nut, M10	2
22	TLX-7000-022	5206-00005-000	Lock nut, M5	8
23	TLX-7000-023	SL03-08001-000	Threaded Drive Bar	2
24	TLX-7000-024	SL03-00012-000	Flat Key	4
25	TLX-7000-025	SJ05-HYZ00-000	Grease Zerk (Flush)	2
26	TLX-7000-026	SL03-00005-000	Gear Box Case	2
27	TLX-7000-027	SL03-06002-000	Linkage Bar (LH)	1
27.1	TLX-7000-027.1	SL03-06002-001	Linkage Bar (RH)	1
28	TLX-7000-028	SL03-00007-000	Linkage Coupler	1
29	TLX-7000-029	5112-05010-FH0	Threaded Pin, M5x10	3
30	TLX-7000-030	SL03-00018-000	Position Ring	2
31	TLX-7000-031	5401-04020-000	Round Pin, D4x20	2
32	TLX-7000-032	SL03-00020-000	Small Gear	2
33	TLX-7000-033	5312-22002-000	Circlips, D22x2	2
34	TLX-7000-034	5602-12010-000	Ball Bearing	4
35	TLX-7000-035	5908-12024-005	Oil Seal	2
36	TLX-7000-036	SL03-06001-000	Hex Socket, H13	2
37	TLX-7000-037	5602-15009-000	Push Bearing (Small)	2
38	TLX-7000-038	SL03-08002-000	Position Ring	2
39	TLX-7000-039	5602-30011-000	Push Bearing (Large)	2
40	TLX-7000-040	SL03-00019-000	Large Gear	2

41	TLX-7000-041	SL03-00021-000	Nut	2
42	TLX-7000-042	SL03-00006-000	Gear Box Cover	2
43	TLX-7000-043	SL03-21002-FJ2	Plastic Cap	4
44	TLX-7000-044	SL03-00011-000	Nylon Bushing	4
45	TLX-7000-045	SL03-07000-000	Linkage Support Tube	2
46	TLX-7000-046	5206-00008-000	Lock Nut, M8	2
47	TLX-7000-047	5206-00006-000	Lock Nut, M6	12
48	TLX-7000-048	5301-00006-000	Flat Washer, D6	12
49	TLX-7000-049	SL03-00023-000	Swivel Caster	3
50	TLX-7000-050	5110-06020-000	Screw, M6x20	12
51	TLX-7000-051	SL03-04000-000	Platform	2
52	TLX-7000-052	SL03-00008-000	Rubber Pad	2
53	TLX-7000-053	SL03-20100-FJ1	Riser Bar	2
53.1	TLX-7000-053.1	SL03-20001-FJ1	Rubber Bar Pad	4
54	TLX-7000-054	SL03-21100-FJ2	Hanger Bracket	1
54.1	TLX-7000-054.1	SL03-21001-FJ2	Rubber Pad	1
55	TLX-7000-055	SL03-10000-000	Drill Drive Adapter	4
56	TLX-7000-056	SL03-00017-000	Swivel Connector, H13	1
57	TLX-7000-057	SL03-09001-000	Hand Crank Bar	1
57.1	TLX-7000-057.1	SL03-09002-000	Pivot Handle	1
57.2	TLX-7000-057.2	5312-16016-000	Circlips, D16x1.6	4
59	TLX-7000-059	5301-00012-000	Flat Washer, D12	12
60	TLX-7000-060	5402-05020-000	Cotter Pin, D5x20	3
<b>JACK STAND</b>				
58	TLX-7000-058	SL03-25000-FJ6	Jack Stand	1
58.1	TLX-7000-058.1	SL03-25300-FJ6	Outer Support Tube	1
58.2	TLX-7000-058.2	5206-00005-000	Lock Nut, M5	9
58.3	TLX-7000-058.3	SL03-00001-FJ6	Circle Frame	3
58.4	TLX-7000-058.4	SL03-25400-FJ6	Leg Pivot Bar	3
58.5	TLX-7000-058.5	5110-05040-000	Screw, M5x40	6
58.6	TLX-7000-058.6	SL03-25200-FJ6	Support Leg	3
58.7	TLX-7000-058.7	SL03-25100-FJ6	Inner Lock Tube & Pad	1
58.8	TLX-7000-058.8	SL03-24004-FJ6	Hitch Pin, D2	1
58.9	TLX-7000-058.9	SL03-25002-FJ6	Pin	1
58.10	TLX-7000-058.10	SL03-25003-FJ6	Ring	1
58.11	TLX-7000-058.11	SL03-25004-FJ6	Chain	1
58.12	TLX-7000-058.12	5110-05016-000	Screw, M5x16	3



# LIMITED WARRANTY

## Structural Warranty:

The following parts and structural components carry a five-year warranty:

Columns	Arms	Uprights	Swivel Pins
Legs	Carriages	Overhead Beam	
Tracks	Cross Rails	Top Rail Beam	

## Limited One-Year Warranty:

Tuxedo Distributors, LLC (iDEAL) offers a limited one-year warranty to the original purchaser of Lifts and Wheel Service equipment in the United States and Canada. Tuxedo will replace, without charge, any part found defective in materials or workmanship under normal use, for a period of one year after purchase. The purchaser is responsible for all shipping charges. This warranty does not apply to equipment that has been improperly installed or altered or that has not been operated or maintained according to specifications.

## Other Limitations:

This warranty does not cover:

1. Parts needed for normal maintenance
2. Wear parts, including but not limited to cables, slider blocks, chains, rubber pads and pulleys
3. Replacement of lift and tire changer cylinders after the first 30 days. A seal kit and installation instructions will be sent for repairs thereafter.
4. On-site labor

Upon receipt, the customer must visually inspect the equipment for any potential freight damage before signing clear on the shipping receipt. Freight damage is not considered a warranty issue and therefore must be noted for any potential recovery with the shipping company.

The customer is required to notify Tuxedo of any missing parts within 72 hours. Timely notification must be received to be covered under warranty.

Tuxedo will replace any defective part under warranty at no charge as soon as such parts become available from the manufacturer. No guarantee is given as to the immediate availability of replacement parts.

Tuxedo reserves the right to make improvements and/or design changes to its lifts without any obligation to previously sold, assembled, or fabricated equipment.

There is no other express warranty on the Tuxedo lifts and this warranty is exclusive of and in lieu of all other warranties, expressed or implied, including all warranties of merchantability and fitness for a particular purpose.

To the fullest extent allowed by law, Tuxedo shall not be liable for loss of use, cost of cover, lost profits, inconvenience, lost time, commercial loss or other incidental or consequential damages.

This Limited Warranty is granted to the original purchaser only and is not transferable or assignable.

Some states do not allow exclusion or limitation of consequential damages or how long an implied warranty lasts, so the above limitations and exclusions may not apply. This warranty gives you specific legal rights and you may have other rights, which may vary from state to state.

8320 E Hwy 67, Alvarado, TX 76009  
Ph. 817-558-9337 / Fax 817-558-9740