



DO THE JOB RIGHT.® 800.343.9353 eastwood.com



Ryan Rossi
Charger R/T

See page 10 for details

SAVE
with this Awesome Combo Deal!

Start serious fabrication with this incredible kit! TIG weld steel, stainless, and aluminum with the TIG 200 AC/DC Welder and cut metal up to 7/8" thick with the Versa-Cut 60 Plasma Cutter.

#98025



Elite AC/DC MP200i Multi-Process Welder

MIG-TIG-ARC weld with this Multi-Process Welder that's a true AC/DC TIG with high frequency start and foot pedal for precision fabrication.

#65375

Elite AC/DC MP200i

The best machine we've tested.
Welds 3/16"



#65375

Elite MP200i

Use all day, every day.
Welds 3/8"



#20569

Elite MP250i

Your all-in-one shop machine.
Welds 1/2"



#54500

True TIG Function

Elite MP140i

The best 120V welder we've ever tested.
Welds 3/16"



#20559

MIG 140

Perfect for sheet metal.
Welds 3/16"



#33970

MIG 180

Great for all areas of restoration.
Welds 5/16"



#33980

#33990 Inc. Spool Gun

MIG 250

Built for hard-core fabrication.
Welds 1/2"



#33930

Versa-Cut 40

Great for auto restoration and most metal fab.
Cuts 3/8"



#59983

Versa-Cut 60

Perfect for thick metal.
Cuts 7/8"



#58221

TIG 200 DC

Versatile 110 or 220v operation.
Welds 1/4"



#20566

TIG 200 AC/DC

Easy-to-use with pro results.
Welds 1/4"



#33920

Elite TIG 200 LCD

Pro-grade TIG welder with LCD, pulse capability and a Gas Lens Kit included.
Welds 1/4"



#61500

Scan the Code!

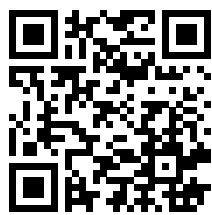

See our complete lineup of welders, accessories, supplies, and how-to videos!

XL View Auto Darkening Helmet

Features "True Color" technology, and "grind" mode.



#21484

2-Unit Welding Cart

Designed to hold a welder, plasma cutter, and 80 cu. ft. bottle.



#11616

Concours LT100 HVLV Spray Paint Gun

Designed to require the least amount of air possible.



#15639

GOOD

Concours II HVLV Spray Paint Gun Kit

Designed for the seasoned pro and hobbyist.



#16287

BETTER

How-To Paint Your Car

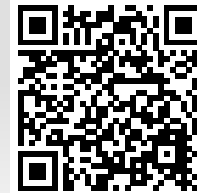

Learn how to get pro results from a driveway paint job!

Concours Pro Standard Paint and Detail Gun Set

Guns as good as top brands, but at a price the home user can afford.



#14776

BETTER

Elite CC500 Color/Clear Paint Gun

Designed by pros for a professional quality paint job. 1.3 and 1.4mm sets included.



#54270

BEST

Elite P500 Primer Paint Gun

Designed by pros for a professional quality paint job. 1.7 and 2.0mm sets included.



#54271

BEST

DeVilbiss® 3-Gun Set

Take on any paint job, from graphics and touch-up tasks to full repaints.



#20491

DeVilbiss® ProLite Gravity Paint Gun

Exceptional performance for hard-to-atomize coatings like pearls and metallics.



#56930

DeVilbiss® DV1 Basecoat Paint Gun

Air and fluid management produces a balanced and consistent spray.



#56919

Eastwood Primers – The foundation of your paint job

From epoxy primer, self etch primer, high build surface primer, to ultra build polyester primer, Eastwood has you covered.



Hundreds of Colors available at eastwood.com



Eastwood Clears – For a show-quality finish

European urethane, high-solids, low-VOC, intercoat, and matte-finish, we have the clear you need.



Premium 3:1 Single-Stage Urethanes and Basecoats

#54515zp Goblin Green Pearl



#52426zp Interstate Black



#54518zp Deep Space Pearl Metallic

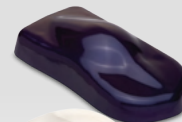

#50212zp Pure White



#14880zp Carbon Metallic



#15703zp Tropical Sunset Orange Pearl



#15707zp Fireball Red Pearl



#15704zp Deep Lagoon Blue



PCS-1000 Elite Powder Coating System

Unparalleled powder coating performance for the pro.



#16164 PCS-1000 System with 5 lb. Hopper

Mini Hopper gives you the ability to do small jobs and change colors quickly.



#54313 2 lb. Hopper

Powder Coating Rack

Weld-together rack kit can be used for hanging parts for powder coating or painting.



#33912

Over 150 Powder Colors available at eastwood.com



Premium UV-Resistant Powders

Available in 8 oz., 1 lb., 25 lb., and 55 lb.

#58202 Punch Pink



#58203 Safety Orange

PCS-250 Dual-Voltage Powder Coating System

Provides switching from 15Kv for smaller parts, to 25Kv for larger parts.



#33278

Powder Coating Accessories Kit

All the accessories needed to start powder coating.



#11536

3-Gallon Oil-Less Pancake Compressor

Perfect for powder coating.



#31289

HotCoat Powder Booth

4' x 4' x 6' booth includes floor pan, lighting, and non-sparking exhaust fan.



#33276

PCS-150 Single-Voltage Powder Coating System

The original DIY powder coating system!



#33272

High Temp Polyester Masking Tape

Available in 1/8" through 2" widths.

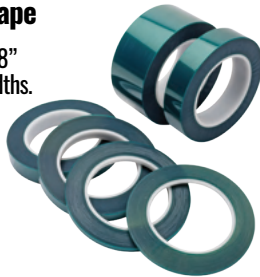

High-Temp Silicone Cap & Plug Kit

Reusable and prevents powder build-up in critical areas.



#58041K

HotCoat Powder Oven

4' x 4' x 6' curing oven quickly gets to, and maintains 400°F.



#33273

Elite 27" Bead Roller



#21327

The largest hand-crank bead roller on the market

Motorized Bead Rollers

Power for pro-quality beads.



#22965 36" Bead Roller

Box Pan Brakes

#20664 12" Box Pan Brake

#20665 24" Box Pan Brake

#20666 48" Box Pan Brake



Perfect for creating complex shapes with removable fingers to create pans or boxes.



3-in-1 Shear, Brake, and Slip Roll

Create channels, ribs, patch panels, cones, cylinders, and more. Bends, rolls, and shears up to 30" or 12" wide steel and aluminum.

#21304 30" 3-in-1

Versa-Bend Sheet Metal Brake

Bench or vise mount brake produces up to 90° bends.

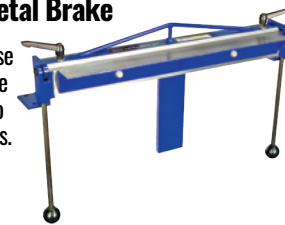

#14042

48" Electro-Brake

Bends up to 16 gauge steel.



#32601

Slip Roll

Creates bends, cones, and cylinders.



#20199 12" Slip Roll

#20254 24" Slip Roll

#59752 50" Slip Roll

Elite Mini English Wheel

An affordable way to get into wheeling. Forms up to 15" wide panels.

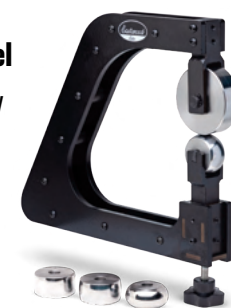

#54830

Ultimate Bead Roller System

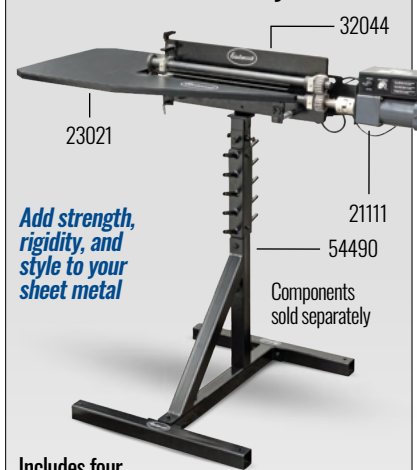

Add strength, rigidity, and style to your sheet metal

Includes four sets of dies. Add the Table, Stand, and Drive for the ultimate setup.

#32044 19" Bead Roller

#23021 Bead Roller Table

#54490 Bead Roller Stand

#21111 Bead Roller Drive System

Heavy-Duty Metal Bender

Form brackets, ironwork, and more with mild steel, round or square rod.



#28135

Shrinker/Stretch Combo Set

Handles most automotive metal-shaping jobs.



#51088

Blast Cabinets – Available in Sizes to Fit Any Space

30721 offers a space-saving design for even the smallest shops.

20464 can be used as a benchtop unit or as a stand-alone (with optional Leg Kit).

98019 can handle parts up to 125 lbs.

21301 can handle parts up to 220 lbs.

66294 can handle parts up to 220 lbs.



30721
3 cu. ft.

Benchtop
or standup!

20464
Shown with
Extended Leg Kit,
sold separately
6 cu. ft.

98019
10.5 cu. ft.

21301
12.1 cu. ft.

66294
14.8 cu. ft.

#30721
Benchtop Cabinet

#20464
B40 Cabinet

#20499
Extended Leg Kit

#98019
B60 Cabinet

#21301
B100 Cabinet

#66294
B120 Cabinet

WARNING: Pressure blasters and blast cabinets emit abrasive particles under high pressure. Adequate respiratory, eye, and body protection must be utilized at all times during product operation. Inhalation of silica-based blast media particles have been known to cause cancer and other deadly diseases and must be avoided. Always wear NIOSH-approved respiratory protection when operating this equipment.

50 lb. Pressure Abrasive Blaster

Large, high-flow valves to speed rust/paint removal.



#51117

100 lb. Soda Blaster

Pressure blaster includes instructions to switch from bicarbonate soda to abrasive use.



#50095

“Master Blaster” Dual Blaster

Quickly switch from abrasive to soda blasting on-the-fly.



#11737

Rust Converter

Turns rust into a paintable surface.



#51483z
Aerosol

#51676zp
Quart

#51677zp
Gallon

Gel Rust Dissolver

Can be applied to vertical surfaces, no need to submerge parts.



#12096
Quart

#12097
Gallon

Internal Frame Coating

Stops rust from the inside out with a special conical nozzle tube.



#15275z
Black

#12515z
Green

Original Rust Encapsulator

One of the most-trusted treatments available.

#16060z Black, Aerosol



Available in textured as well as colors.

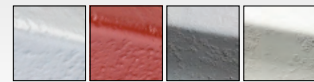

Rust Encapsulator PLUS

2X the protection of Original Rust Encapsulator. Black color.



#54292z
Pint

#54290zp
Quart

#54291zp
Gallon

Rust Encapsulator PLATINUM

Beats all competition for rust treatment. Silver color.



#16259z
Pint

#16258zp
Quart

#16257zp
Gallon

*Special shipping charges may apply

Variable Speed 6" Orbital Sander/Polisher

Powerful 7.5 AMP, soft-start motor.



#32489

Bench Grinder/Belt Sander

2" x 28" belt sands, grinds, finishes, sharpens, cleans, deburrs, and files.



#13577

Disc/Belt Sander

2" x 42" belt and 6" disc accepts common DA paper.

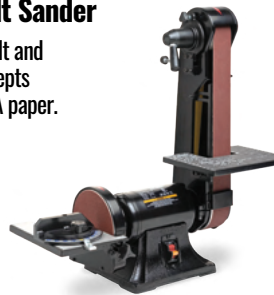

#22979

Disc/Belt Sander

4" belt, 6" disc for grinding, shaping, and smoothing.



#13660

Metal Cutting Jig Saw

Includes 10 FREE premium Starrett blades.



#32290

Contour SCT

The BEST Way to Strip Rust, Paint, and Body Filler!

The Surface Conditioning Tool is a heavy-duty, professional-quality tool designed to quickly surface metal or tackle any paint or rust stripping project. In-line design eliminates torque load.



Full line of abrasive drums available

#21145

Benchtop Metal Cutting Bandsaw

A must for cutting tubing, flat stock, round stock, angle iron easily and accurately.



#20237

Mini Metal Saw

Cold-cutting saw cuts without sparks.



#31664

Throatless Sheet Metal Shears

Cuts straight or tight curves in up to 18 gauge stainless.



#20644

#20523 Repl. Blades

Electric Shears

Easily slice through up to 18 gauge stainless.



#13475

12" Disc Sander

Vertical sanding surface with a 45° adjustable work table.



#21535

Electric Mini Belt Sander

180° swivel head gets into really tight spaces. Tool-less quick change belts.



#31672

Variable Speed 7-9" Buffer/Polisher

Soft start feature keeps compound on the pad.



#32488

Evolution Steel Cutting Chop Saws

No heat, no burrs, virtually no sparks.



#21986 7.25" Saw

#54320 14" Saw

*Special shipping charges may apply

Pneumatic Perfect Panel Prep Tool

Quickly create a 45° offset butt welding metal.



#21128

Pneumatic Rotary Removal Tool

Quickly remove rust, paint, decals, and more!



#30216

Pro Mini Belt Sander

Fully adjustable sanding arm holds a 1/2" x 18" sanding belt. Perfect for tight spot sanding.



#31455

Pistol Grip 3" Orbital Sander

Precision-balanced for low vibration and higher performance.



#31658

1/4" Air Die Grinder

Aluminum-bodied with a precision-balanced motor and infinite speed control.



#31659

Pro Mini Angle Belt Sander

3/4" x 20.5" belt is perfect for tubes and rounded surfaces.



#31649

50' Retractable Air Hose Reel with Hybrid Flex Polymer Hose

Have your shop air ready when you need it.



#32499

2" Surface Prep Tool

Uses 2" Roloc™-style discs to quickly remove paint, rust, and gaskets.



#31820 Prep Tool

#31821 Repl. 2" Pads

3" Adjustable Head Cut Off Tool

Head adjusts 25° to let you work in confined areas.



#31847

Impact Air Ratchet

Easily break fasteners loose. Designed for tight spaces.



#31752 1/4" Drive

#31753 3/8" Drive

3" Inline Cut Off Tool

Laser-straight cuts made easy with a high torque motor.



#31921

3" Long Reach Cut Off Tool

Cut in tight spaces.



#51680

Elite Panel Cutting Saw

Makes straight, plunge, and scroll cuts with a counter-rotating 3" diamond blade.



#98014

Elite Deburring Tool

Easily removes plasma slag and grinds down weld beads with a 2" diamond wheel.



#98015

Needle Scaler

Works fast on heavy rust, scale, and caked-on grime.



#31819

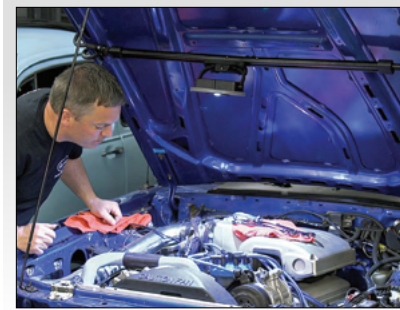

LED Lighting System *Mix & Match Components to Build the Ultimate Lighting Setup*



#32400 LED Light Module



#32401 Underhood Bracket/Light Mount

#32403 Light Mount



LED lights sold separately

#32402 Tripod Stand

Shop Presses

#54440 10 Ton Benchtop

#54441 12 Ton Floor

#54442 20 Ton Floor



7" x 12" Metal-Cutting Bandsaw

Built for professionals and cuts up to a 7" x 10.5" rectangle.

#21980



Benchtop Bandsaw

Ideal for cutting tubing, flat and round stock, and angle iron.

#20237



Heavy-Duty Body Cart

Supports up to 2000 lbs. yet is completely portable for rolling body shells.

#31539



3000 lb. Rotisserie

#32194



The perfect way to access every side of a vehicle for restoration.

Ultrasonic Cleaners

Provides precise, damage-free cleaning of grimy parts.

#33969 9 Liter

#37365 27 Liter



Impact Air Ratchet

Easily break fasteners loose. Designed for tight spaces.



#31752 1/4" Drive

#31753 3/8" Drive

3" Inline Cut Off Tool

Laser-straight cuts made easy with a high torque motor.



#31921

3" Long Reach Cut Off Tool

Cut in tight spaces.



#51680

3.5-Gallon Benchtop Parts Washer

Fits where larger washers won't. Electric pump with adjustable spigot.

#30640



20-Gallon Parts Washer

For bigger jobs. Includes removable shelf, parts bin, and flow-through brush.

#14293



40-Gallon Parts Washer

For the biggest jobs – like an entire transmission!

#31875



Modular Work Bench

59.5" x 27.5" work surface.

#98018



Heavy-Duty Tear-Down Table

47" x 32" work surface with drain and basin.

#98017



Tear-Down Table

27" x 16" surface for smaller tear-down jobs.

#31652



Ryan Rossi

Charger R/T

THE Garage BUILT BY Eastwood



Looking at the immaculate Plum Crazy Purple finish on this 1968 Dodge Charger, you'd never know it was the work of just one man. But that's what Ryan Rossi did, resurrecting it from a rusty heap entirely on his own in the 11' x 20' cinder block garage next to his house. A BMW technician by trade but with a passion for classic Mopars, it took him 15 years to complete, but the effort was clearly worth it.

"The first 10 years were all bodywork, including building a rotisserie, replacing the floors, trunk, quarter panels, and rear valance," Ryan tells us. "Then the suspension and drivetrain. The interior is still in the works," he adds even though it's nearly complete at this point.

He picked up the non-running donor in 2001, but it sat for the first six years as wife, daughter and house took priority. It gave him time to figure out a game plan. Originally, he just wanted to drop in a 440 engine, weld up the rusty floors, paint it black, and drive it. "But as it sat in storage, my vision changed to a complete restoration and some upgrades," he recalls, "including fuel injection on a bored and stroked big block, plus an overdrive transmission."

He built up a 440 V8 to 512 cubic inches, performing all the work on his own except for the engine boring. He built the 46RH overdrive automatic on the same bench. But the biggest challenge for Ryan, who works with mechanical issues all day long, was the repairing the bodywork. As he puts it, "It was a rusted-out basket case... I did all the blasting, stripping, cutting, welding, grinding, paint..." adding that he fabricated a rotisserie specifically for his car and his tight workspace.

Ryan says he couldn't have done it without Eastwood. "I used a lot of Chassis Black. I also used Eastwood's high-temp ceramic engine paints on the engine, transmission, brakes and most suspension components. I went through many cans of Internal Frame Coating inside the new rockers. Fast Etch rust stripper worked great and was a real time saver. I can't even remember all the Eastwood polishes and buffers I used, as well as some of the other special coatings."

The results speak for themselves. Ryan says the Charger is like a "people magnet" whenever he pulls into a car show or stops for gas. It's a testament to planning, patience, and persistence, and he just looks forward to finishing the interior so he can really start sharing it with other Mopar fans.



Read the full story, along with other projects here:
<https://www.eastwood.com/garage/>

Or Scan the Code

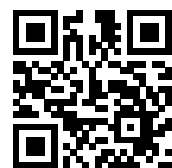

Products Used

2K Ceramic Chassis Black



#54299zp Gallon
 #15993zp Activator

Ceramic Engine Paint Hemi Orange



#51620zp Quart
 #21854z Activator

Internal Frame Coating, Aerosol



#12515z Green
 #15275z Black

Fast Etch Rust Remover



#19416 32 oz.
 #19418 Gallon

Buffing Shop Kit



#13109k 8"
 #32028k 10"

Metal Blackening System



#15357z

NEW

METRO
Moulded Parts Inc

HD2P-9000AF, Floorplate, Symmetric, 9000 lb. Capacity



#54559



Heavy Duty 16"x16" Auto Dolly, Set of 4



#21697



Mini-Ductor Venom MDV-777



#59812



RAGE Ultra Xtra Body Filler, Gallon



#16190zp



NEW

Fragola
Performance Systems

2-Ton Triple Lift Floor Jack



#61867



'63-'87 Chevy C10 Coil-Over Conversion Kit



#23419



Auto Paint and Priming Starting Line System



#12506



4PC HVLP Triple Setup Spray Gun Kit



#63116



Reversible Flex head Cut Off Tool



#59620



3/4" Fastpipe Master Kit, 90'



#55266



Easy Street 4 Barrel Kit, 600HP, Classic Gold with Force Fuel System



#23156



3/4" Maxline Master Kit, 300'



#55267



Sportsman Pro Series Seat, Black Vinyl, Common Side



#66821



26" Rapid Box with Magnetic Front Cover



#56675



EZ-ON Hose Press 409B



#66951



3 Drawer Slide Top Utility Cart



#61661



Mobile Welding Table Cart 48" x 30" x 35", 1,750 lb. capacity



#67207



5" Non-Vac Dynorbital Spirit Random Orbital Sander



#63889



350 ci. 341 HP Fully Dressed Crate Engine



#63242



Fuel Tank Repair Kit



#13431zp



7PC Hammer and Dolly Auto Body Repair Kit



#55785



SDPL-8000, Four-Post, 8000 lb. Capacity



#54567



20V MAX 3/8" Impact Wrench Kit



#66895



7PC Set with Soap Hook and Loop



#55129



Professional Workbench



#63091



Rhino Pull 1000 lb. Portable Winch, 24V



#67353



1500 lb. Wheel Dolly



#61353



Pure 1 Regenerative Desiccant Air Dryer System



#67453





Elite MP200i Multi Process Welder



#20569

Rockwood Auto Darkening Welding Helmet



#32082

Electric Metal Cutting Shears



#13475

Stubby Flex Head Ratchet



#32523 1/4" Drive
#32524 3/8" Drive

Auto Rewind Electric Cord Reel



#33092

Concours Exterior Car Washing Starter Kit



#98047

Master Blaster Dual Abrasive and Soda Blaster



#11737

48" Electro-Brake Sheet Metal Brake



#32601

EZ-Turn Engine Stand



#31551

Elite CC500 Color and Clearcoat HVLP Paint Gun



#54270

COB LED Rechargeable Work Light



#32406

Mini Metal Saw



#31664

Elite Contour Dustless Sanding Block, Base Kit



#65500

Heavy Duty 750 lb. Work Stand



#43120

Professional Brake Line and Tubing Flaring Tool



#25304

Yost Model 32C 4-1/2" Heavy Duty Combination Vise with Swivel Base

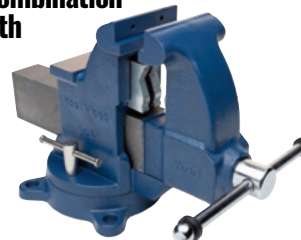

#56389

PCS-250 Dual Voltage Powder Coating Gun



#33278

Fender Cover



#55804

Concours Exterior Car Washing Complete Kit



#98048

Elite Mini English Wheel



#54830

1HP, Dual Speed, Professional Buff Motor



#64732

B40 Modular Blast Cabinet



#20464

6PC Axial Welding Pliers Set



#23004

Elite MP140i Multi Process Welder



#20559

10PC Deep Impact Socket Set



#32088 SAE
#32089 Metric

Contour Pro 6" Random Orbital Sander, 3/32" Orbit



#31251

Concours LT100 HVLP Paint Gun



#15639

Extra-Wide Aerosol Can Rack



#31501

Products not included

Reciprocating Air Body Saw



#13745

Scan the Code!

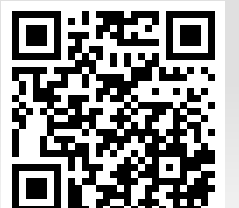

See the entire Gift Guide!

Scan
the
Code!

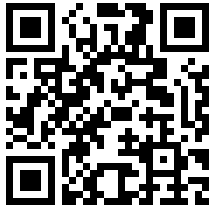

See All
Hot Products!

Sheet Metal Plug Hole Patch Kit

Precisely fill holes from rust, door locks, antennas, and more.



#54820

Concours Paint Gun Stand

Fully configurable and compatible with most HVLP and gravity feed paint guns.



#55001

Adjustable Valve Spring Compressor

Removes valve springs on cylinder heads after head is removed.



#22126

TIG Mate TIG Pen

Allows consistent feeding of filler rod for improved weld strength and appearance.



#33996

Eastwood TIG Pyrex Gas Lens Kits



#61047 21PC

#61048 1/16" 9PC

#61049 3/32" 9PC

Elite Contour Dustless Sanding Block, Essentials Kit

Dustless sanding blocks keeps you and your shop clean!



#98067

Elite AC/DC MP200i

MIG-TIG-ARC weld with this multi-process welder that's a true AC/DC TIG.



#65375

Super Flex Tool Tray Set

Set of three trays are super-flexible to mold to any surface and offer a non-slip grip.



#33964

Inline Wire Stripper

Quickly and cleanly strip wires in tough-to-access areas.



#33933

Ultrasonic Cleaners

Provides precise, damage-free cleaning of grimy parts.



33969

#33969 9 Liter

#37365 27 Liter

PRE Green

Our popular PRE Painting Prep is now available in a 50-State compliant formula!



#60022 Quart Spray

#60023 Gallon

#60024 Wipes

Rally Silver Wheel Paint



#10001z 1K Aerosol

#33908z 2K AeroSpray

Rally Charcoal Wheel Paint



#33909z 2K AeroSpray

Rally Black Satin Wheel Paint



#10085z 1K Aerosol

#33910z 2K AeroSpray